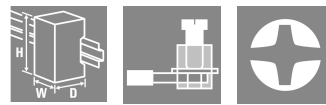

**ACT20P-RTI-AO-S**

**Weidmüller Interface GmbH & Co. KG**  
Klingenbergstraße 26  
D-32758 Detmold  
Germany

www.weidmueller.com

**Product image, Similar to illustration**

ACT20P: The flexible solution

- Precise and highly functional signal converters
- Release levers simplify handling

**General ordering data**

Version	Temperature converter, Input : Temperature, PT100, Output : 0(4)-20 mA
Order No.	<a href="#">7760054233</a>
Type	ACT20P-RTI-AO-S
GTIN (EAN)	6944 169696411
Qty.	1 items

## ACT20P-RTI-AO-S

Weidmüller Interface GmbH &amp; Co. KG

Klingenbergstraße 26

D-32758 Detmold

Germany

www.weidmueller.com

## Technical data

## Approvals

Approvals



ROHS Conform

## Dimensions and weights

Depth	114 mm	Depth (inches)	4.4882 inch
Height	117 mm	Height (inches)	4.6063 inch
Width	12.5 mm	Width (inches)	0.4921 inch
Net weight	110 g		

## Temperatures

Storage temperature	-40 °C...85 °C	Operating temperature	-20 °C...60 °C
Humidity	5...95 %, no condensation		

## Environmental Product Compliance

RoHS Compliance Status	Compliant with exemption
RoHS Exemption (if applicable/known)	7a, 7cl
REACH SVHC	Lead 7439-92-1
SCIP	2f6dd957-421a-46db-a0c2-cf1609156924

## Input

Sensor	2-/3-wire, PT100, Cu50, Cu100	Number inputs	1
Line resistance in measuring circuit	≤ 50 Ω	Temperature input range	Configurable, PT100: -200...+850 °C, min. measurement range 10°C (RTD)

## Output

Number of outputs	1	Load impedance current	≤ 550 Ω
Wire break detection	Yes, Output value: 22 mA	Type	active, connected control must be passive
Output current	Adjustable, 0(4)...20 mA		

## General data

Accuracy	0.2 °C/0.1% of end value	Protection degree	IP20
Supply voltage	24 V DC ± 20 %	Step response time	≤1s
Current consumption	<50 mA @ IOU = 20 mA	Mounting rail	TS 35
Power consumption	ca. 1.5 W	Temperature coefficient	≤ 100 ppm/K
Configuration	With free software ACT20P TOOL PACK, Requires configuration adapter 8978580000 CBX200 USB, + 2907490000 ADAPTER CBX200 - MINI USB	Operating altitude	≤ 2000 m

## ACT20P-RTI-AO-S

**Weidmüller Interface GmbH & Co. KG**

Klingenbergstraße 26  
D-32758 Detmold  
Germany

[www.weidmueller.com](http://www.weidmueller.com)

## Technical data

### Insulation coordination

Impulse withstand voltage	4 kV (1.2/50 µs)	EMC standards	EN 61326-1
Test voltage	0.3 kV	Surge voltage category	III
Pollution severity	2	Galvanic isolation	between input / output / supply
Insulation voltage	2 kV inputs / outputs / power supply	Rated voltage	300 V

### Connection data

Type of connection	Screw connection	Tightening torque, max.	0.6 Nm
Clamping range, rated connection	2.5 mm <sup>2</sup>	Clamping range, min.	0.5 mm <sup>2</sup>
Clamping range, max.	2.5 mm <sup>2</sup>	Wire connection cross section AWG, min.	AWG 30
Wire connection cross section AWG, max.	AWG 14		

### Classifications

ETIM 8.0	EC002919	ETIM 9.0	EC002919
ETIM 10.0	EC002919	ECLASS 14.0	27-21-01-29
ECLASS 15.0	27-21-01-29		

ACT20P-RTI-AO-S

Weidmüller Interface GmbH & Co. KG  
 Klingenbergstraße 26  
 D-32758 Detmold  
 Germany

Drawings

www.weidmueller.com

Connection diagram

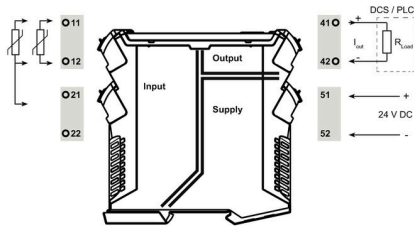

Dimensioned drawing

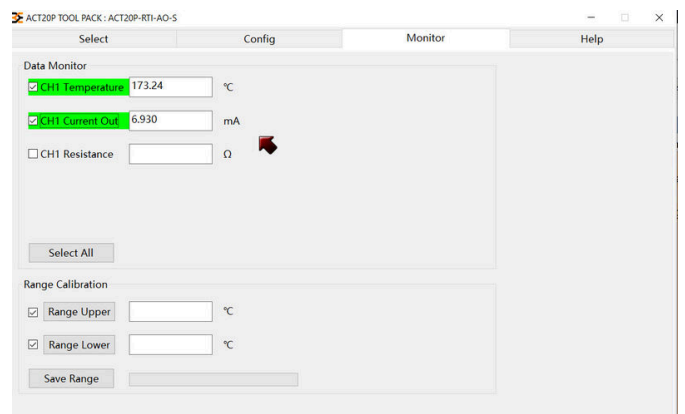
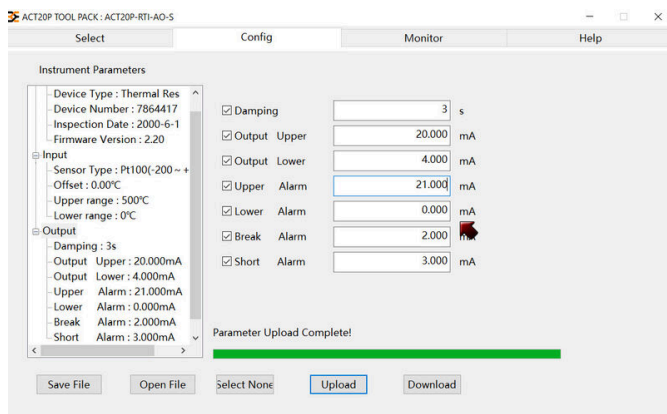
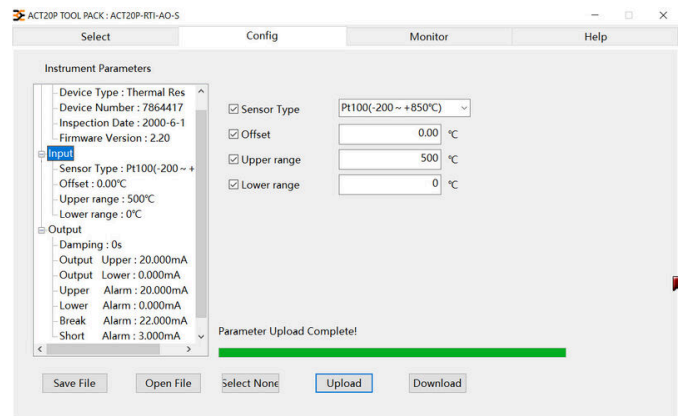
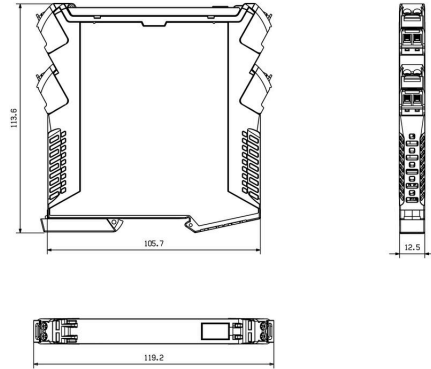

# Drawings

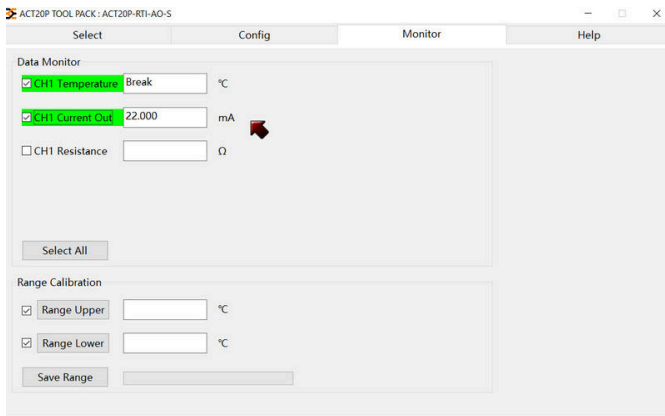

## ACT20P-RTI-AO-S

Weidmüller Interface GmbH &amp; Co. KG

Klingenbergstraße 26

D-32758 Detmold

Germany

www.weidmueller.com

## Accessories

## Blank



ESG is the tried-and-tested marker in MultiCard format for use on many well-known electrical devices. The result is high-quality device marking with a high-contrast appearance.

Various types are available for devices from manufacturers like Siemens, ABB, Beckhoff etc.

Advantages at a glance:

- Tags for universal usage, self-adhesive or clip-on tags, depending on type
- For aligned equipment, e.g. circuit breakers, we supply ESG markers for clipping onto tag rails
- Individual laser-quality printing according to specifications

For custom printing: Please send us a file of our labeling software M-Print PRO or M-Print PRO Online (without installation) for your labeling specifications.

## General ordering data

Type	ESG 6.6/20 BHZ 5.00/04	Version	
Order No.	<a href="#">1082540000</a>	ESG, Device markers x 20 mm, PA 66, Colour: white, pluggable	
GTIN (EAN)	4032248845439		
Qty.	200 ST		
Type	ESG 8/13.5/43.3 SAI AU	Version	
Order No.	<a href="#">1912130000</a>	ESG, Device markers x 13.5 mm, PA 66, Colour: Transparent, pluggable	
GTIN (EAN)	4032248541164		
Qty.	5 ST		

## Configuration interfaces



## General ordering data

Type	CBX200 USB	Version	
Order No.	<a href="#">8978580000</a>		
GTIN (EAN)	4032248813759		
Qty.	1 ST		
Type	ADAPTER CBX200 - MINI U...	Version	
Order No.	<a href="#">2907490000</a>		
GTIN (EAN)	4099986188617		
Qty.	1 ST		